

SINGER
123W

LIST OF PARTS



MACHINES OF CLASS 123w

INDEX

	Page
Accessories	26
Bobbin Winder	26
Foot Lifter	27
Guide For Bag Handles	30
Knee Lifter	28
Machine No.123w1	7
Machine No.123w2	13
Machine No.123w3	19
Machine No.123w4	20
Numerical List Of Parts	31
Obsolete Parts	30
Presser Feet	29
Throat Plates	29

INSTRUCTIONS FOR ORDERING

In ordering from this list, use ONLY the PART number in the FIRST column.

The number stamped on a Sewing Machine Part is the number of the Single Part only, except when the part includes Set Screws, Clamping Screws, Studs and Rollers Spun on, Small Wires riveted, or Parts soldered together, etc., which it is necessary to furnish in combination.

Every combination of parts sent out has its specific number which, although not stamped on Parts (except in above case), must be used when ordering the combination.

Each number always indicates the SAME PART in whatever list it appears, or for whatever Machine.

The letters after some of the numbers indicate the style of finish only, as follows:

- A. Hardened, Polished and Plated.
- B. Polished and Plated.
- C. Hardened only.
- D. Polished only.
- E. Soft, not polished.
- F. Hardened and Polished.
- H. Blued.
- J. Nickle Plated only.
- R. Merlized.
- Y. Black Nickle Plated only.

These letters MUST BE USED when they appear in the list and AFTER the number, as in the list.

In this series

- 200001 to 201500 and 350001 to 351500 are Screw Numbers.
- 201501 to 201800 and 351501 to 351800 are Nut Numbers.
- 201801 to 202000 and 351801 to 352000 are Roller Numbers.
- 202001 to 350000 are Numbers of Machine Parts.

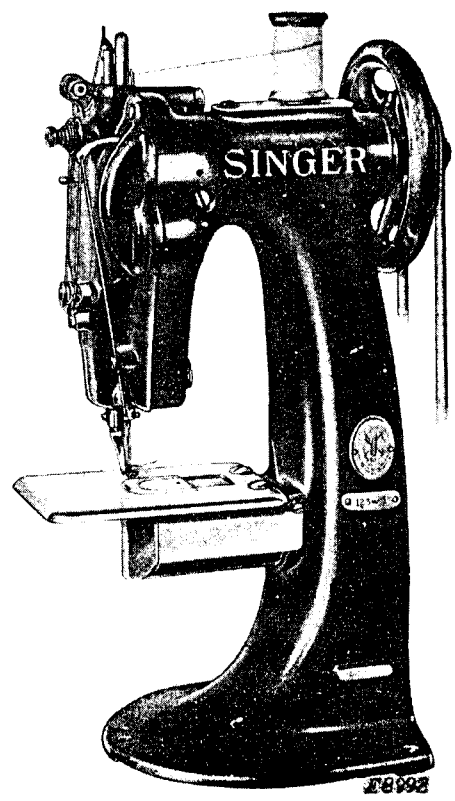
The figures in the second column refer only to the plate in which the illustration of the part is shown and are NOT TO BE USED in ordering.

Two or more numbers over a cut indicate that the difference between such parts is not visible in an illustration.

Parts marked with an asterisk (*) are furnished only when repairs are made at the factory.

LIST OF PARTS COMPLETE

FOR



MACHINE No. 123 w 1

CYLINDER BED. NEEDLE FEED.
ALTERNATING PRESSERS

FOR LEATHER, GLOVES, ETC.

No.	Plate	Name
*213523	-----	Arm and Bed
213526	11359	" Cap with 213539 and 213540
200276H	11360	" " Screw

No.	Plate	Name
202248H	11360	Arm Cap Screw Washer
213527	11359	" Shaft
223607	11359	" " Bushing (back) with 202260
202280	-----	" " " " Oil Packing (wick)
200352C	11360	Arm Shaft Bushing (back) Set Screw
213524	11359	" " " (front) with 202260
202280	-----	" " " " Oil Packing (wick)
200352C	11360	Arm Shaft Bushing (front) Set Screw
213528	11362	Balance Wheel (belt groove 2-3/4 in. diam.) with 200328C and 200335C
200062H	11360	Balance Wheel Adjusting Screw
200328C	11360	" " Position Screw
200335C	11360	" " Set Screw
213783	11360	Bobbin
213615	-----	" Case
203648	11360	" " Latch
*202056	-----	" " Pin
213932	11360	" " Plunger
203474	11360	" " Spring
213531	11360	" " Lever
213447	11360	" " Arm with 200099H
213529	11360	" " Bracket
200076D	11360	" " " " Screw
200099H	11360	" " Pinch Screw
213445	11360	" " Tension Spring
200984C	11360	" " " " Regulating Screw
200594C	11360	Bobbin Case Tension Spring Screw
213703	11360	Bobbin Case complete, Nos. 200594C, 200984C, 202056, 203474, 203648, 213445, 213615 and 213932
213530	11362	Cylinder End Cover
200132D	11360	" " " Screw
200334C	11360	" " " Stop Screw
221580	11362	Face Plate with 200368H, 200739F, 202087, 202090, 213691 and four 200397H
200053C	11360	Face Plate Screw (2)
200739F	11360	" " Thread Guide Screw
221581	-----	Face Plate complete, Nos. 200577H, 202088, 204272, 204280, 210957, 210958, 210992, 210993, 213500, 213690, 221580 and two 200309E
213464	11363	Feed Cam
213692	11363	" " Position Pin (2)
201827	11363	" " Roller
201821	-----	" " " 201827 with 200818C
200818C	11363	" " " Screw Stud
201522E	11363	" " " " Nut

No.	Plate	Name
200035E	11363	Feed Cam Screw
213465	11359	" Connection
213466	11363	" " Link
213467	11363	" " " Lever
200101D	11363	" " Stop Screw
213463	11359	" Eccentric Connection with 200066D
200066D	11363	" " " Pinch Screw
213460	11362	" and Needle Carrying Frame with 213711
215688	-----	Feed and Needle Carrying Frame 213460 with 200101D, 201522E, 201821, 213461, 213463 to 213467, 213474, 213475, 213461, 213483, 213485 to 213488, 213673, 221561 and two 213484
213711	11363	Feed and Needle Carrying Frame Bushing
213639	11363	" " " " Collar with 350355C
350355C	11363	Feed and Needle Carrying Frame Collar Set Screw
213461	11363	Feed and Needle Carrying Frame Link
213494	11359	" Regulating Lever
213696	11363	" " Friction Washer
200095B	11363	" " " Screw
213496	11363	" " " Segment
201183D	11363	" " " " Screw
200681C	11363	" " " " Stop Screw
227364	11362	Foot Lifter Lifting Lever
213547	-----	" " " " 227364 with 200262H and 213546
200262H	11363	Foot Lifter Lifting Lever Hinge Screw
213548	11364	" " " " Spring
200335C	11360	" " " " Screw
*221652	-----	Hook (sewing)
221653	11364	" 221652 with 201253F, 201376F, 203251, 221588 and two 200590H
221654	-----	Hook and Bobbin Case complete, Nos. 213703 and 221653
213533	11364	Hook Bushing
200382C	11364	" " Set Screw
213536	11359	" Driving Gear (intermediate)
213534	11359	" " " and Thread Draw Cam with 200380C and 200443C
200443C	11364	Hook Driving Gear and Thread Draw Cam Position Screw
200380C	11364	Hook Driving Gear and Thread Draw Cam Set Screw
213535	11359	Hook Gear with two 200380C
200380C	11364	" " Set Screw
203251	11364	" Gib
201376F	11364	" " Hinge Screw

No.	Plate	Name
201253F	11364	Hook G1b Screw
221588	11364	" Washer
200590H	11364	" " Screw
213537	11359	" Saddle with 200382C,213533 and two 200076D
200858E	11364	Hook Saddle Screw (2)
213480	11361	Lifting Presser Bar with 200074F
213481	11364	" " " Collar with 200572F and two 200386C
200386C	11364	Lifting Presser Bar Collar Set Screw
200572F	11364	" " " " Slide Adjusting Screw
200490B	11364	Lifting Presser Bar Sleeve Screw and Nut
213482	11364	Lifting Presser Bar Spring
200635B	11364	" " " " Follower Screw
200613F	11365	" " " " " " Position Screw
214057	11365	Lifting Presser Bar Vibrating Lever
213483	-----	" " " " " " " 214057 with 200230F and 201525E
200230F	11365	Lifting Presser Bar Vibrating Lever Hinge Screw
201525E	11365	Lifting Presser Bar Vibrating Lever Hinge Screw Nut
213485	11365	Lifting Presser Bar Vibrating Lever Rocker Arm
213486	11365	Lifting Presser Bar Vibrating Lever Rocker Arm Link
213484	11365	Lifting Presser Bar Vibrating Lever Slide Block
229760	11372	Lifting Presser Foot
200074F	11365	" " " " Screw
221561	11361	Needle Bar with 200134F,200587D and 204487
213474	11365	Needle Bar Collar with 200049D and 200572F
200049D	11365	Needle Bar Collar Set Screw
200572F	11364	" " " " Slide Adjusting Screw
213475	11365	" " " " Connecting Link
204487	11365	" " " " Thread Guide
200587D	11365	" " " " " " Screw
200134F	11365	" " " " " " Set Screw
202554	11365	Presser Bar Lifter
200026D	11365	" " " " Hinge Screw
213490	11366	" " " " Shoe and Tension Release Stud
213540	11366	Spool Holder Washer
213539	11366	" " " " Wire

No.	Plate	Name
213673	11361	Take-up Cam with 200335C,200383C and 200430C
200430C	11366	Take-up Cam Position Screw
200383C	11366	" " " " " Check Screw
200335C	11360	" " " " " Set Screw
213498	11366	" Lever
221572	-----	" " 213498 with 213697
213697	11366	" " " Bearing with 204264
204264	11366	" " " " Position Pin
200042F	11366	" " " " " Screw
201816	11366	" " " " " Roller
213499	-----	Take-up Lever complete,Nos.200042F, 201816 and 221572
244048	11366	Tension Disc
202090	11366	" " " " Position Pin
213500	11366	" Release Lever
200309E	11366	" " " " " Screw
202075	11366	" " " " " Plunger
202407	11366	" Spring
200632B	11366	" Stud
200397H	11366	" " " " " Set Screw
201572B	10881	" Thumb Nut
204271	11366	" Washer
204272	-----	Tension complete,Nos.200632B,201572B, 202075,202407,204271 and two 244048
204274	11367	Thread Controller Plate
200577H	11367	" " " " " Screw
202098	11367	" " " " " Roller
204275	11367	" " " " " Guard
202084	11367	" " " " " Washer
200300C	11367	" " " " " Screw
204276	11367	" " " " " Spring
204333	11367	" " " " " Guard
200581H	11367	" " " " " " Screw
202087	11367	" " " " " Stop
202088	11367	" " " " " Stud with 204925
200368H	11367	" " " " " " Set Screw
204925	11367	" " " " " " Washer
205987	-----	Thread Controller complete,Nos.200300C, 200581H,202084,202098,204274,204275 and 204333
204280	-----	Thread Controller and Spring complete, Nos.204276 and 205987
213541	11367	Thread Draw with 200387C and 200447C
213542	11361	" " " " " Driving Lever with 200054E
200054E	11367	" " " " " " Pinch Screw
201851	11367	" " " " " " Roller
200447C	11367	" " " " " " Position Screw
200387C	11367	" " " " " " Set Screw
213543	11367	" " " " " " Shaft

No.	Plate	Name
213489	11367	Thread Guide (left)
200389C	11367	" " Set Screw
202482	11367	" Retainer Disc
213691	11367	" " Guide Wire
200397H	11366	" " " " Set Screw
210993	11367	" " Sleeve
202483	11367	" " Spring
210992	11367	" " "
200631E	11365	" " Stud
210957	11367	" " "
210956	11367	" " " Collar
201574D	11367	" " " Nut
200397H	11366	" " " Set Screw
213690	-----	Thread Retainer complete, Nos. 200631E, 201574D, 202463 and two 202482
213899	-----	Throat Plate, 53 needle hole, for needle sizes 12 to 20
212851	11373	Throat Plate 213899 with 212873
200132D	11360	" " Screw (2)
212873	11373	" " Slide
213544	11362	Vertical Shaft
221563	11361	" " Driving Gear (steel), 20 teeth
206126	-----	Vertical Shaft Driving Gear 221563 with two 200383C
200383C	11366	Vertical Shaft Driving Gear Set Screw
221563	11366	" " Gear (steel), 20 teeth
221549	-----	" " 221563 with 200383C and 200396C
200396C	11368	Vertical Shaft Gear Position Screw
200383C	11366	" " " Set Screw
213545	11362	" " Hanger
213487	11361	Vibrating Presser Bar with 200389C
213488	11368	" " " Collar with 200386C and 200572F
200386C	11364	Vibrating Presser Bar Collar Set Screw
200572F	11364	" " " " Slide Adjusting Screw
213484	11365	Vibrating Presser Bar Collar Slide Block
213489	11367	Vibrating Presser Bar Thread Guide (left)
200389C	11367	Vibrating Presser Bar Thread Guide Set Screw
229751	11372	Vibrating Presser Foot, 46 needle hole, with 200941C
200941C	11368	Vibrating Presser Foot Pinch Screw
213546	11362	Work Plate
201011B	11368	" " Screw (2)

LIST OF PARTS COMPLETE
FOR
MACHINE No. 123w2
CYLINDER BED. NEEDLE FEED.
ALTERNATING PRESSERS

FOR LEATHER, GLOVES, ETC.

No.	Plate	Name
*213523	-----	Arm and Bed
213526	11359	" Cap with 213539 and 213540
200278H	11360	" " Screw
202246H	11360	" " " Washer
213527	11359	" Shaft
223607	11359	" " Bushing (back) with 202260
202260	-----	" " " " Oil Packing (wick)
200352C	11360	Arm Shaft Bushing (back) Set Screw
213524	11359	" " " (front) with 202260
202260	-----	" " " " Oil Packing (wick)
200352C	11360	Arm Shaft Bushing (front) Set Screw
213528	11362	Balance Wheel (belt groove 2-3/4 in. diam.) with 200328C and 200335C
200062H	11360	Balance Wheel Adjusting Screw
200328C	11360	" " Position Screw
200335C	11360	" " Set Screw
213783	11360	Bobbin
*213615	-----	" Case
203648	11360	" " Latch
*202056	-----	" " " Pin
213932	11360	" " " Plunger
203474	11360	" " " Spring
213531	11360	" " Lever
213447	11360	" " " Arm with 200099H
213529	11360	" " " Bracket
200076D	11360	" " " " Screw
200099H	11360	" " " " Pinch Screw
213445	11360	" " Tension Spring
200984C	11360	" " " " Regulating Screw
200594C	11360	Bobbin Case Tension Spring Screw
213703	11360	Bobbin Case complete, Nos. 200594C, 200984C, 202056, 203474, 203648, 213445, 213615 and 213932
213530	11362	Cylinder End Cover

PARTS FOR MACHINE 123w2

No.	Plate	Name
200132D	11360	Cylinder End Cover Screw
200334C	11360	" " " Stop Screw
221580	11362	Face Plate with 200368H, 200739F, 202087, 202090, 213691 and four 200397H
200053C	11360	Face Plate Screw (2)
200739F	11360	" " Thread Guide Screw
221581	-----	Face Plate complete, Nos. 200577H, 202088, 204272, 204280, 210957, 210958, 210992, 210993, 213500, 213690, 221580 and two 200309E
213464	11363	Feed Cam
213692	11363	" " Position Pin (2)
201827	11363	" " Roller
201821	-----	" " " 201827 with 200818C
200818C	11363	" " " Screw Stud
201522E	11363	" " " " " Nut
200035E	11363	" " Screw
213465	11359	" Connection
213466	11363	" " Link
213467	11363	" " " Lever
200101D	11363	" " Stop Screw
213463	11359	" Eccentric Connection with 200066D
200066D	11363	" " " Pinch Screw
213460	11362	" and Needle Carrying Frame with 213711
215688	-----	Feed and Needle Carrying Frame 213460 with 200101D, 201522E, 201821, 213461, 213463 to 213467, 213474, 213475, 213461, 213483, 213485 to 213488, 213673, 221561 and two 213484
213711	11363	Feed and Needle Carrying Frame Bushing
213639	11363	" " " " Collar with 350355C
350355C	11363	Feed and Needle Carrying Frame Collar Set Screw
213461	11363	Feed and Needle Carrying Frame Link
213494	11359	" Regulating Lever
213551	11368	" " " Connection
213506	11368	" " " " Pin (2)
213702	11368	" " " Packing Washer
200095B	11363	" " " Screw
213496	11363	" " " Segment
201183D	11363	" " " " Screw
200681C	11363	" " " " Stop Screw
213550	11361	" Reversing Lever
213552	11362	" " " Connection Rod
212614	11368	" " " " " Block with 200529C
200529C	11368	Feed Reversing Lever Connection Rod Block Set Screw

PARTS FOR MACHINE 123w2

No.	Plate	Name
202302	11368	Feed Reversing Lever Connection Rod Cotter Pin
200217H	11368	Feed Reversing Lever Hinge Screw
221547	11368	" " " Spring
200835D	11368	" " " " Stop Screw
227364	11362	Foot Lifter Lifting Lever
221568	-----	" " " " 227364 with 200217H and 213548
213546	11364	Foot Lifter Lifting Lever Spring
200335C	11360	" " " " " Screw
*221652	-----	Hook (sewing)
221653	11364	" 221652 with 201253F, 201376F, 203251, 221588 and two 200590H
221654	-----	Hook and Bobbin Case complete, Nos. 213703 and 221653
213533	11364	Hook Bushing
200382C	11364	" " Set Screw
213536	11359	" Driving Gear (intermediate)
213534	11359	" " " and Thread Draw Cam with 200360C and 200443C
200443C	11364	Hook Driving Gear and Thread Draw Cam Position Screw
200380C	11364	Hook Driving Gear and Thread Draw Cam Set Screw
213535	11359	Hook Gear with two 200380C
200380C	11364	" " Set Screw
203251	11364	" Gib
201376F	11364	" " Hinge Screw
201253F	11364	" " Screw
213537	11359	" Saddle with 200382C, 213533 and two 200076D
200858E	11364	Hook Saddle Screw (2)
221588	11364	" Washer
200590H	11364	" " Screw
213460	11361	Lifting Presser Bar with 200074F
213481	11364	" " " Collar with 200572F and two 200386C
200386C	11364	Lifting Presser Bar Collar Set Screw
200572F	11364	" " " " Slide Adjusting Screw
200490B	11364	Lifting Presser Bar Sleeve Screw and Nut
213482	-----	Lifting Presser Bar Spring
200635B	11364	" " " " Follower Screw
200613F	11365	" " " " " " Position Screw
214057	11365	Lifting Presser Bar Vibrating Lever
213483	-----	" " " " " " 214057 with 200230F and 201525E

No.	Plate	Name
200230F	11365	Lifting Presser Bar Vibrating Lever Hinge Screw
201525E	11365	Lifting Presser Bar Vibrating Lever Hinge Screw Nut
213465	11365	Lifting Presser Bar Vibrating Lever Rocker Arm
213486	11365	Lifting Presser Bar Vibrating Lever Rocker Arm Link
213484	11365	Lifting Presser Bar Vibrating Lever Slide Block
229760	11372	Lifting Presser Foot
200074F	11365	" " " Screw
221561	-----	Needle Bar with 200134F, 200567D and 204487
213474	11365	Needle Bar Collar with 200049D and 200572F
200049D	11365	Needle Bar Collar Set Screw
200572F	11364	" " " Slide Adjusting Screw
213475	11365	" " Connecting Link
204487	11365	" " Thread Guide
200587D	11365	" " " " Screw
200134F	11365	" Set Screw
202554	11365	Presser Bar Lifter
200026D	11365	" " " Hinge Screw
213490	11366	" " " Shoe and Tension Release Stud
213540	11366	Spool Holder Washer
213539	11366	" " Wire
213673	11361	Take-up Cam with 200335C, 200383C and 200430C
200430C	11366	Take-up Cam Position Screw
200363C	11366	" " " " Check Screw
200335C	11360	" " Set Screw
213498	11366	" Lever
221572	-----	" " 213498 with 213697
213697	11366	" " Bearing with 204264
204264	11366	" " " Position Pin
200042F	11366	" " " Screw
201816	11366	" " Roller
213499	-----	Take-up Lever complete, Nos. 200042F, 201816 and 221572
244048	11366	Tension Disc
202090	11366	" " Position Pin
213500	11366	" Release Lever
200309E	11366	" " " Screw
202075	11366	" " Plunger
202407	11366	" Spring
200632B	11366	" Stud
200397H	11366	" " Set Screw
201572B	10881	" Thumb Nut

No.	Plate	Name
204271	11366	Tension Washer
204272	-----	Tension complete, Nos. 200632B, 201572B, 202075, 202407, 204271 and two 244048
204274	11367	Thread Controller Plate
200577H	11367	" " " Screw
202098	11367	" " " Roller
204275	11367	" " " Guard
202084	11367	" " " Washer
200300C	11367	" " " Screw
204276	11367	" " Spring
204333	11367	" " " Guard
200581H	11367	" " " " Screw
202087	11367	" " " Stop
202088	11367	" " " Stud with 204925
200368H	11367	" " " Set Screw
204925	11367	" " " Washer
205987	-----	Thread Controller complete, Nos. 200300C, 200581H, 202084, 202098, 204274, 204275 and 204333
204280	-----	Thread Controller and Spring complete, Nos. 204276 and 205987
213541	11367	Thread Draw with 200387C and 200447C
213542	11361	" " Driving Lever with 200054E
200054E	11367	" " " " Pinch Screw
201851	11367	" " " " Roller
200447C	11367	" " Position Screw
200387C	11367	" " Set Screw
213543	11367	" " Shaft
213489	11367	" Guide (left)
200369C	11367	" " Set Screw
202482	11367	" Retainer Disc
213691	11367	" " Guide Wire
200397H	11366	" " " " Set Screw
210993	11367	" " Sleeve
202483	11367	" " Spring
210992	11367	" " "
200631E	11365	" " Stud
210957	11367	" " "
210958	11367	" " " Collar
201574D	11367	" " " Nut
200397H	11366	" " " Set Screw
213690	-----	Thread Retainer complete, Nos. 200631E, 201574D, 202483 and two 202482
213899	-----	Throat Plate, 53 needle hole, for needle sizes 12 to 20
212851	11373	Throat Plate 213899 with 212873
200132D	11360	" " Screw (2)
212873	-----	" " Slide
213544	11362	Vertical Shaft

No.	Plate	Name
221563	11368	Vertical Shaft Driving Gear (steel), 20 teeth
206126	-----	Vertical Shaft Driving Gear 221563 with two 200383C
200383C	11366	Vertical Shaft Driving Gear Set Screw
221563	11368	" " Gear (steel) 20 teeth
221549	-----	" " " 221563 with 200383C and 200396C
200396C	11368	Vertical Shaft Gear Position Screw
200383C	11366	" " " Set Screw
213545	11362	" " Hanger
213487	11361	Vibrating Presser Bar with 200389C
213488	11368	" " " Collar with 200386C and 200572F
200386C	11364	Vibrating Presser Bar Collar Set Screw
200572F	11364	" " " Slide Adjusting Screw
213484	11365	Vibrating Presser Bar Collar Slide Block
213489	11367	" " " Thread Guide (left)
200389C	11367	" " " " Set Screw
229751	11372	Vibrating Presser Foot, 46 needle hole, with 200941C
200941C	11368	Vibrating Presser Foot Pinch Screw
213546	11362	Work Plate
201011B	11368	" " Screw (2)

MACHINE No. 123w3

CYLINDER BED. NEEDLE FEED. ALTERNATING PRESSERS FOR POCKET-BOOK WORK.

Same as Machine 123w2 with the following exceptions:

No.	Plate	Name
*213549	-----	Arm and Bed, in place of 213523
213511	11368	Feed Connection Link Lever, in place of 213467
221565	-----	Feed and Needle Carrying Frame 213460 with 200101D, 201522E, 201821, 213461, 213463 to 213466, 213474, 213475, 213481, 213483, 213485 to 213488, 213511, 213673, 221561 and two 213484, in place of 215688
213508	11368	Feed Regulating Lever Segment (for forward feed), in place of 213496
213509	11369	Feed Regulating Lever Segment (for reverse feed)
200162D	11369	Feed Regulating Lever Segment Set Screw
201231C	11369	" " " " Stop Screw, in place of 200681C
213900	-----	Throat Plate, 53 needle hole, for needle sizes 12 to 20, in place of 213899
212852	11373	Throat Plate 213900 with 212873, in place of 212851

LIST OF PARTS COMPLETE

FOR

MACHINE No. 123w4

CYLINDER BED. NEEDLE FEED.
ALTERNATING PRESSERSFOR STITCHING A LARGE HARD CORD OR WELT AROUND THE TOPS
OF INNER SOLES WITHOUT FLATTENING IT.

No.	Plate	Name
*213523	-----	Arm and Bed
213526	11359	" Cap with 213539 and 213540
200276H	11360	" " Screw
202246H	11360	" " " Washer
213527	11359	" Shaft
223607	11359	" " Bushing (back) with 202260
202260	-----	" " " " 011 Packing (wick)
200352C	11360	Arm Shaft Bushing (back) Set Screw
213524	11359	" " " (front) with 202260
202260	-----	" " " " 011 Packing (wick)
200352C	11360	Arm Shaft Bushing (front) Set Screw
213554	11361	Base Plate
200599D	11369	" " Screw (2)
213528	11362	Balance Wheel (belt groove 2-3/4 in. diam.) with 200328C and 200335C
200062H	11360	Balance Wheel Adjusting Screw
200328C	11360	" " Position Screw
200335C	11360	" " Set Screw
213783	11360	Bobbin
*213615	-----	" Case
203646	11360	" " Latch
*202056	-----	" " " Pin
213932	11360	" " " Plunger
203474	11360	" " " Spring
213531	11360	" " Lever
213447	11360	" " Arm with 200099H
213529	11360	" " " Bracket
200076D	11360	" " " " Screw
200099H	11360	" " " " Pinch Screw
213445	11360	" " Tension Spring
200984C	11360	" " " " Regulating Screw
200594C	11360	" " " " Screw

No.	Plate	Name
213703	11360	Bobbin Case complete, Nos. 200594C, 200984C, 202056, 203474, 203648, 213445, 213615 and 213932
213557	11369	Cloth Guide
213562	11369	" " Adjustable Stop
200132D	11360	" " " " Screw
202603	11369	" " " " Washer
200336E	11369	" " Adjusting Screw
213784	11369	" " Bell Crank with 200609F
213560	11369	" " " " Bracket
200577H	11367	" " " " " Screw
213561	11359	" " " " Connection Chain
213584	11361	" " " " " Rod
200609F	11369	" " " " " " Posi- tion Screw
200248F	11369	Cloth Guide Bell Crank Hinge Screw
213559	11369	" " Connection Lever with 200336E
200911E	11369	Cloth Guide Connection Lever Hinge Screw
213555	11369	Cloth Guide Position Guide
200056D	10684	" " " " " Screw
202603	11369	" " " " " Washer
226263	11369	" " Spring
213785	-----	Cord Stitching Attachment complete, Nos. 200132D, 200248F, 200911E, 213554, 213555, 213557, 213559 to 213562, 213584, 213784, 226263, two each 200056D, 200577H, 200599D and three 202603
213558	11362	Cylinder End Cover
200132D	11360	" " " " Screw
200334C	11360	" " " " Stop Screw
221580	11362	Face Plate with 200368H, 200739F, 202087, 202090, 213691 and four 200309H
200053C	11360	Face Plate Screw (2)
200739F	11360	" " Thread Guide Screw
221581	-----	Face Plate complete, Nos. 200577H, 202088, 204272, 204280, 210957, 210958, 210992, 210993, 213500, 213690, 221580 and two 200309E
213464	11363	Feed Cam
213692	11363	" " Position Pin (2)
201827	11363	" " Roller
201821	-----	" " " 201827 with 200818C
200618C	11363	" " " " " Screw Stud
201522E	11363	" " " " " Nut
200035E	11363	" " " " " Screw
213465	11359	" Connection
213466	11363	" " Link

No.	Plate	Name
213467	11363	Feed Connection Link Lever
200101D	11363	" " Stop Screw
213463	11359	" Eccentric Connection with 200066D
200066D	11363	" " " Pinch Screw
213460	11362	" and Needle Carrying Frame with 213711
215688	-----	Feed and Needle Carrying Frame 213460 with 200101D, 201522E, 201821, 213461, 213463 to 213467, 213474, 213475, 213481, 213483, 213485 to 213488, 213673, 221561 and two 213484
213711	11363	Feed and Needle Carrying Frame Bushing
213639	11363	" " " " " Collar with 350355C
350355C	11363	Feed and Needle Carrying Frame Collar Set Screw
213461	11363	Feed and Needle Carrying Frame Link
213494	11359	" Regulating Lever
213696	11363	" " " Friction Washer
200095B	11363	" " " Screw
213496	11363	" " " Segment
201183D	11363	" " " Screw
200681C	11363	" " " Stop Screw
227364	11362	Foot Lifter Lifting Lever
213547	-----	" " " " 227364 with 200262H and 213548
200262H	11363	Foot Lifter Lifting Lever Hinge Screw
213548	11364	" " " Spring
200335C	11360	" " " Screw
*221652	-----	Hook (sewing)
221653	11364	" 221652 with 201253F, 201376F, 203251, 221588 and two 200590H
221654	-----	Hook and Bobbin Case complete, Nos. 213703 and 221653
213533	11364	Hook Bushing
200362C	11364	" " Set Screw
213536	11359	" Driving Gear (intermediate)
213534	11359	" " and Thread Draw Cam with 200380C and 200443C
200443C	11364	Hook Driving Gear and Thread Draw Cam Position Screw
200380C	11364	Hook Driving Gear and Thread Draw Cam Set Screw
213535	11359	Hook Gear with two 200360C
200360C	11364	" " Set Screw
203251	11364	" Gib
201376F	11364	" " Hinge Screw
201253F	11364	" " Screw
213537	11359	" Saddle with 200362C, 213533 and two 200076D

No.	Plate	Name
200858E	11364	Hook Saddle Screw (2)
221588	11364	" Washer
200590H	11364	" " Screw
213480	11361	Lifting Presser Bar with 200074F
213481	11364	" " " Collar with 200572F and two 200386C
200386C	11364	Lifting Presser Bar Collar Set Screw
200572F	11364	" " " Slide Adjusting Screw
200490B	11364	Lifting Presser Bar Sleeve Screw and Nut
213482	11364	Lifting Presser Bar Spring
200635B	11364	" " " Follower Screw
200613F	11365	" " " " " Position Screw
214057	11365	Lifting Presser Bar Vibrating Lever
213463	-----	" " " " " 214057 with 200230F and 201525E
200230F	11365	Lifting Presser Bar Vibrating Lever Hinge Screw
201525E	11365	Lifting Presser Bar Vibrating Lever Hinge Screw Nut
213485	11365	Lifting Presser Bar Vibrating Lever Rocker Arm
213486	11365	Lifting Presser Bar Vibrating Lever Rocker Arm Link
213484	11365	Lifting Presser Bar Vibrating Lever Slide Block
229945	11372	Lifting Presser Foot
200074F	11365	" " " Screw
221581	11361	Needle Bar with 200134F, 200587D and 204487
213474	11365	Needle Bar Collar with 200049D and 200572F
200049D	11365	Needle Bar Collar Set Screw
200572F	11364	" " " Slide Adjusting Screw
213475	11365	" " Connecting Link
204487	11365	" " Thread Guide
200587D	11365	" " " Screw
200134F	11365	" Set Screw
202554	11365	Presser Bar Lifter
200026D	11365	" " " Hinge Screw
213490	11366	" " " Shoe and Tension Release Stud
213540	11366	Spool Holder Washer
213539	11366	" " Wire
213673	11361	Take-up Cam with 200335C, 200383C and 200430C
200430C	11366	Take-up Cam Position Screw
200363C	11366	" " " " Check Screw

PARTS FOR MACHINE 123w4

No.	Plate	Name
200335C	11360	Take-up Cam Set Screw
213498	11366	" Lever
221572	-----	" " 213498 with 213697
213697	11366	" " Bearing with 204264
204264	11366	" " " Position Pin
200042F	11366	" " " Screw
201816	11366	" " Roller
213499	-----	Take-up Lever complete, Nos. 200042F, 201816 and 221572
244048	11366	Tension Disc
202090	11366	" " Position Pin
213500	11366	" Release Lever
200309E	11366	" " " Screw
202075	11366	" " Plunger
202407	11366	" Spring
200632B	11366	" Stud
200397H	11366	" " Set Screw
201572B	10881	" Thumb Nut
204271	11366	" Washer
204272	-----	Tension complete, Nos. 200632B, 201572B, 202075, 202407, 204271 and two 244048
204274	11367	Thread Controller Plate
200577H	11367	" " " Screw
202098	11367	" " Roller
204275	11367	" " Guard
202084	11367	" " " Washer
200300C	11367	" " " Screw
204276	11367	" " Spring
204333	11367	" " Guard
200581H	11367	" " " Screw
202087	11367	" " Stop
202088	11367	" " Stud with 204925
200368H	11367	" " " Set Screw
204925	11367	" " " Washer
205987	-----	Thread Controller complete, Nos. 200300C, 200581H, 202084, 202098, 204274, 204275 and 204333
204280	-----	Thread Controller and Spring complete, Nos. 204276 and 205987
213541	11367	Thread Draw with 200387C and 200447C
213542	11361	" " Driving Lever with 200054E
200054E	11367	" " " Pinch Screw
201851	11367	" " " Roller
200447C	11367	" " Position Screw
200387C	11367	" " Set Screw
213543	11367	" " Shaft
213489	11367	" Guide (left)
200389C	11367	" " Set Screw
202482	11367	" Retainer Disc
213691	11367	" " Guide Wire

PARTS FOR MACHINE 123w4

No.	Plate	Name
200397H	11366	Thread Retainer Guide Wire Set Screw
210993	11367	" " Sleeve
202483	11367	" " Spring
210992	11367	" " "
200631E	11365	" " Stud
210957	11367	" " "
210958	11367	" " " Collar
201574D	11367	" " " Nut
200397H	11366	" " " Set Screw
213690	-----	Thread Retainer complete, Nos. 200631E, 201574D, 202483 and two 202482
213901	-----	Throat Plate, 53 needle hole, for needle sizes 12 to 20
212854	-----	Throat Plate Cord Guide
200585H	11360	" " " " Screw
200132D	11360	" " Screw (2)
212873	11373	" " Slide
212855	11373	Throat Plate complete, Nos. 212854, 212873, 213901 and two 200585H
213544	11362	Vertical Shaft
221583	11368	" " Driving Gear (steel), 20 teeth
206128	-----	Vertical Shaft Driving Gear 221583 with two 200383C
200383C	11366	Vertical Shaft Driving Gear Set Screw
221563	11368	" " Gear (steel), 20 teeth
221549	-----	" " " 221563 with 200383C and 200396C
200396C	11368	Vertical Shaft Gear Position Screw
200383C	11366	" " " Set Screw
213545	11362	" " Hanger
213487	11361	Vibrating Presser Bar with 200389C
213488	11368	" " " Collar with 200386C and 200572F
200386C	11364	Vibrating Presser Bar Collar Set Screw
200572F	11364	" " " Slide Adjusting Screw
213484	11365	Vibrating Presser Bar Collar Slide Block
213489	11367	Vibrating Presser Bar Thread Guide (left)
200389C	11367	Vibrating Presser Bar Thread Guide Set Screw
229946	11372	Vibrating Presser Foot, 46 needle hole, with 200941C
200941C	11368	Vibrating Presser Foot Pinch Screw

ACCESSORIES

FOR MACHINE 123w1

No.	Plate	Name
226314	11370	Angle Screw Driver (large)
226315	11370	" " " (small)
213783	11360	Bobbin (5)
*225482	-----	" Case Screw Driver Blade
*225483	-----	" " " " Handle
225497	11156	Bobbin Case Screw Driver complete, Nos.225482 and 225483
120341	11361	Tweezers (curved)
134 x 2	-----	Needles (Reverse Twist Spear Point), two each, sizes 16, 18 and 20
51078	11370	Machine Bolt (4)
6055	11370	" " Washer (4)
120342	11156	Oiler (copper plated) with 120343
120343	11156	" Spout, 3 in. long
*225484	-----	Screw Driver Blade
*225485	-----	" " Handle
225498	11156	Screw Driver, 7-1/4 in. long, complete, Nos. 225484 and 225485
225554	11156	Wrench (steel)

BOBBIN WINDER

Swing Automatic, Right Hand

225453	10884	Frame with 202277 and 225438
225454	10884	" Hinge Pin
202277	-----	" Oil Packing (wick)
225438	10884	" " Well Cap
225455	10884	" Spring
225456	10884	" " Plunger
202473	10885	Pulley with 200380C
200380C	11364	" Set Screw
225381	10884	Spindle
225444	10884	Stop Latch
200056E	10884	" " Screw
225458	10884	" " Thumb Lever
225459	10884	" " " " Hinge Stud
225459	10884	" " " " Joint Stud
202478	10884	" " Trip Lever
200299H	10884	" " " " Hinge Screw
225461	10881	Tension Bracket with 201499B
200082D	10881	" " Screw
226026	10884	" " " Washer

No.	Plate	Name
2102	10881	Tension Disc
202407	10881	" Spring
201499B	10881	" Stud
201572B	10881	" " Thumb Nut
225462	10881	Bobbin Winder Tension Bracket complete, Nos.201572B,202407,225461 and two 2102
225433	10885	Bobbin Winder and Tension Bracket Base
225382	10885	Universal Bobbin Winder complete, Nos. 200056E, 200082D, 200299H, 202473, 202478, 225381, 225433, 225444, 225453 to 225456, 225458, 225462, 228026, two each 225459 and wood screws 3/4 in., No.12, R.H.B.

FOOT LIFTER

227952	11156	Foot Lifter Lever (left or right) with 227954
227678	11156	Foot Lifter Lever Chain, 48 in. long with 202784
227954	11370	Foot Lifter Lever Chain Hook (lower)
202784	11370	" " " " " (upper)
225016	11370	" " " Hinge Pin
227953	11156	" " " Stand with two wood screws 1 in. No.12
227955	11156	Foot Lifter Lever (left or right) com- plete, Nos.225016, 227678, 227952 and 227953

(Other Foot Lifter Parts are listed with parts
of machine head.)

FOR MACHINES 123w2 and 123w3

Same as for No.123w1 with the following exceptions:

227678	11371	Feed Reversing Lever Chain, 48 in. long, with 202784
202784	11370	Feed Reversing Lever Chain Hook
213701	11371	" " " " Lever with 213504, 213700 and two wood screws 1 in. No.13, in place of 227955
213700	11370	Feed Reversing Lever Chain Lever Hinge Pin
213504	11371	Feed Reversing Lever Chain Lever Lug

No.	Plate	Name
2763	11371	Rock Shaft
12242	11371	" " Hanger (back) with two wood screws 1 in. No.10
21327	11371	Rock Shaft Hanger (front) with two wood screws 1 in. No.10
228562	11371	Rock Shaft Knee Arm
228563	-----	Rock Shaft Knee Arm complete, Nos. 1507R, 2766, 2767 and 228562
2766	11370	Rock Shaft Knee Arm Hub with 356C
356C	11370	" " " " Set Screw
1507R	11370	" " " " Lock Nut
2767	11371	" " " " Plate with 356C
228255	11370	" " " " Counter Balance Spring
356C	11370	Rock Shaft Knee Plate Set Screw
6337	11371	" " Lifting Bracket with two 356C
356C	11370	" " " " Set Screw
39811	11371	" " " " Extension with 39576
356C	11370	Rock Shaft Lifting Bracket Extension Set Screw
227676	11371	Rock Shaft Lifting Chain with 202784
202784	11370	" " " " Hook (upper)
39576	11370	" " " " " (lower)
2770	11371	" " Stop Dog with 356C
356C	11370	" " " " Set Screw
228251	11371	Knee Lifter Rock Shaft complete, Nos. 2763, 6337, 12242, 21327, 39811, 227676, 228255, 228563, Form A1070 and two 2770

FOR MACHINE 123w4

Same as for 123w1 with the following addition:

228251	11371	Knee Lifter Rock Shaft complete, Nos. 2763, 6337, 12242, 21327, 39811, 227676, 228255, 228563, Form A1079 and two 2770
--------	-------	--

PRESSER FEET

No.	Plate	Name
229760	11372	Lifting Presser Foot, for 299751
229945	11372	" " " " for 229946
229947	11372	" " " " for 229948
229751	11372	Vibrating Presser Foot, 46 needle hole, with 200941C, for 229760
229946	11372	Vibrating Presser Foot, 46 needle hole, with 200941C, for 229945
229948	11372	Vibrating Presser Foot, 40 needle hole, with 200941C, for 229947

THROAT PLATES

FOR MACHINES 123w1 and 123w2

213899	-----	Throat Plate, 53 needle hole, for needle sizes 12 to 20
212851	11373	Throat Plate 213899 with 212873
212873	11373	" " Slide

FOR MACHINE 123w3

213900	-----	Throat Plate, 53 needle hole, for needle sizes 12 to 20
212878	-----	Throat Plate, 46 needle hole, for needle sizes 20 to 24
214031	-----	Throat Plate, 50 needle hole, for needle sizes 18 to 22
212852	11373	Throat Plate 213900 with 212873
212879	11373	" " 212878 with 212873
214032	11373	" " 214031 with 212873
212873	11373	" " Slide

FOR MACHINE 123w4

213901	-----	Throat Plate, 53 needle hole, for needle sizes 12 to 20
*212854	-----	Throat Plate Cord Guide
200585H	11360	" " " " Screw
212873	11373	" " Slide
212855	11373	Throat Plate complete, Nos. 212854, 212873, 213901 and two 200585H

GUIDE FOR BAG HANDLES

FOR MACHINE 123w1

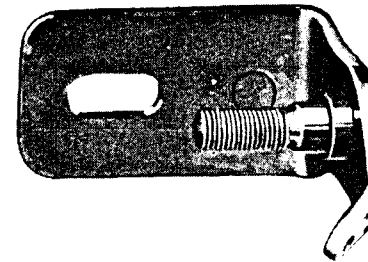
No.	Plate	Name
229002	11374	Guide
229003	11374	" Arm with 200098A
229004	11374	" " Bracket with 200347C
200570E	11360	" " " Screw
200347C	11360	" " Screw
200098A	11360	" Screw
229005	-----	Guide complete, Nos. 229002 to 229004 and two 200570E

OBSOLETE PARTS

213458	11374	Face Plate with 200366H, 200739F, 202087, 202090, 213502, 213691, 221546 and four 200397H
213459	-----	Face Plate complete, Nos. 200577H, 202088, 204272, 204280, 213458, 213500, 213690 and two 200309E
213462	11374	Feed Eccentric
213497	11374	Take-up Cam with 200335C, 200383C and 200430C

PLATE 10881—FULL SIZE

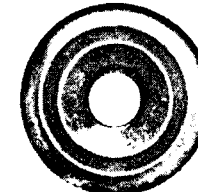
225461



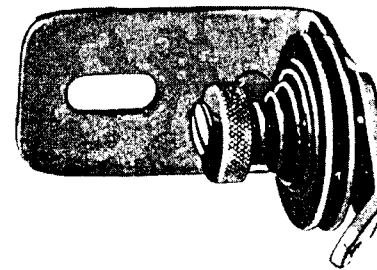
200082 202104



2102



225462



202407



201499



201572



PLATE 10884 - FULL SIZE

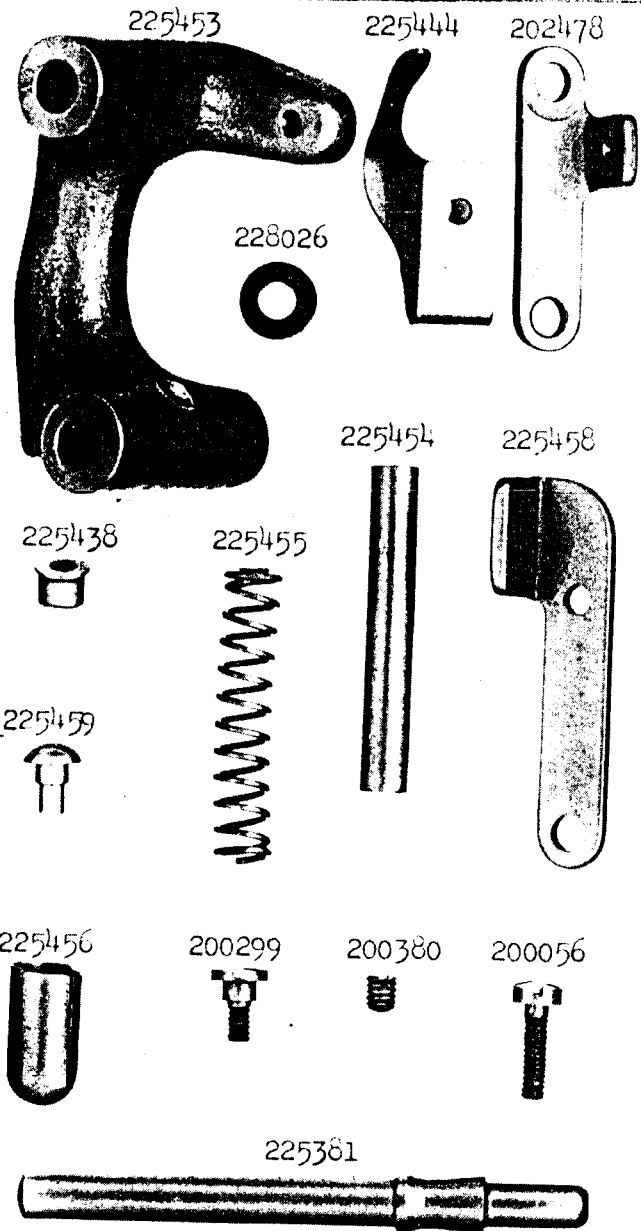


PLATE 10885 - ONE-FOURTH SIZE

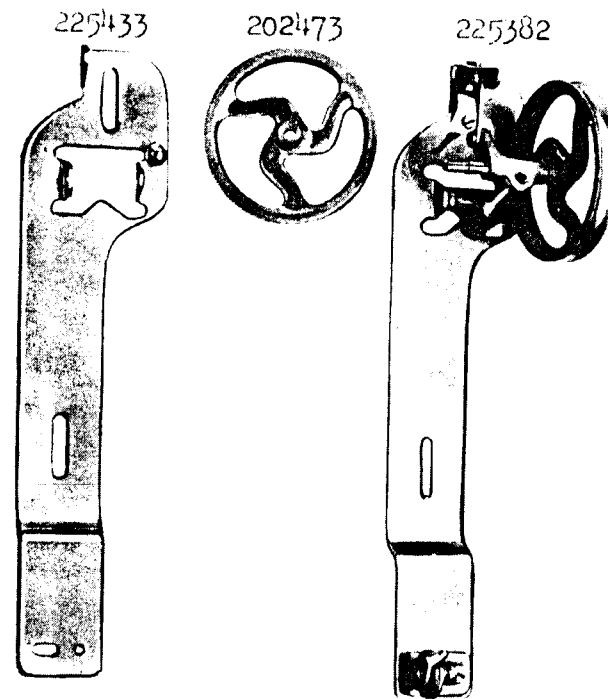


PLATE 11156 - ONE-FOURTH SIZE

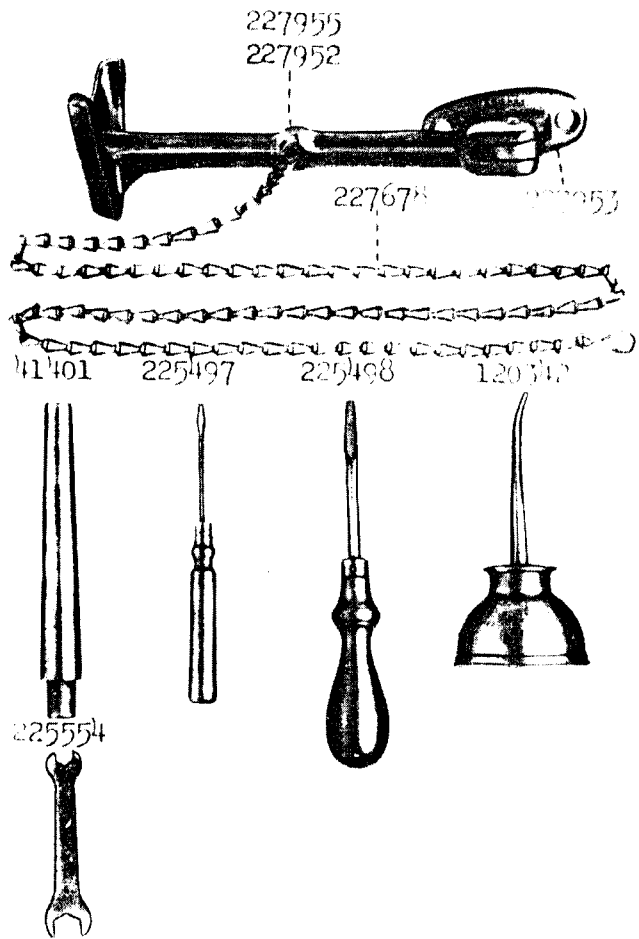


PLATE 11359 ONE-HALF SIZE

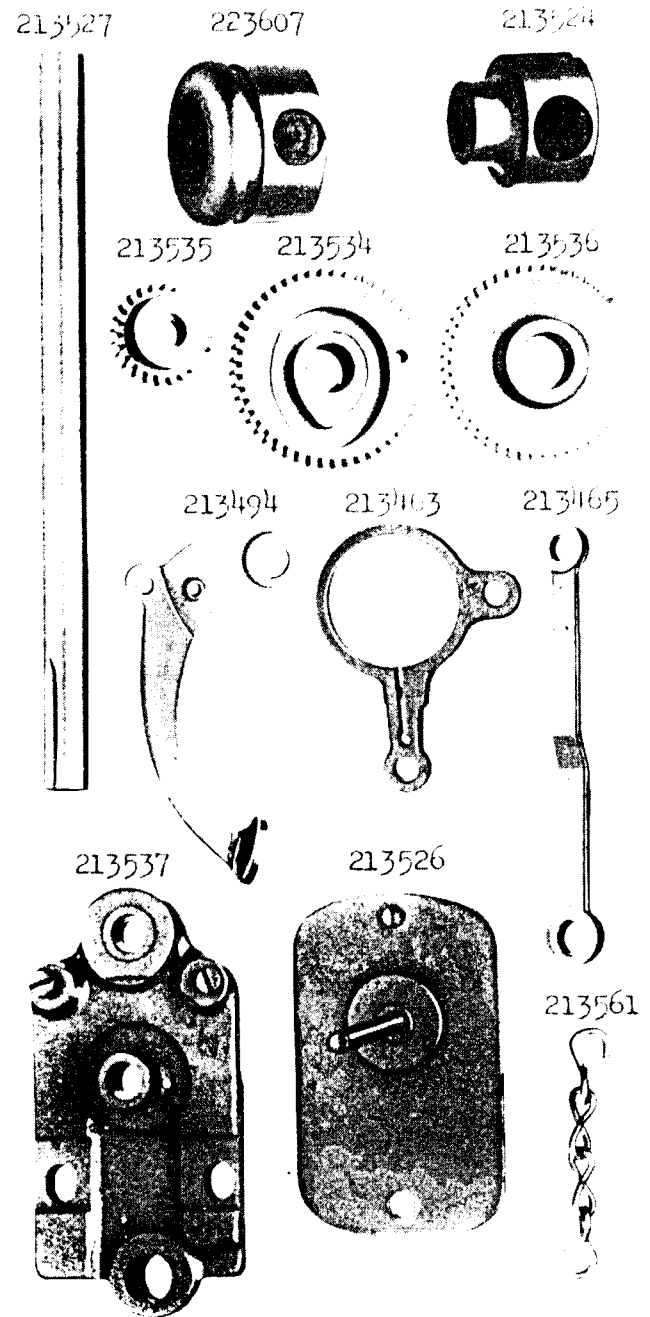
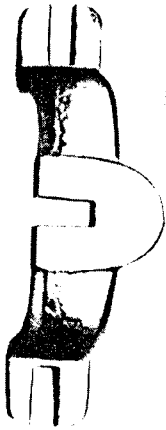
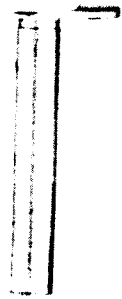


PLATE 11360 FULL SIZE

213722



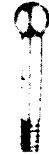
213531



200328

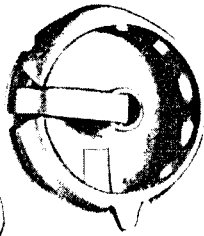


200739



200984 200594

213703



213715



203774



202248



200062



200334



200053



200594

213705



213707



203010



200132



200278



200335



200098



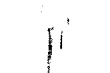
200570



213709



213732



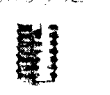
200099



200076



200342



200317



200565



PLATE 11361 ONE-HALF SIZE

221561



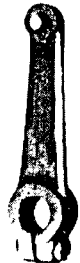
213673



213787



213542



213780



120341



213550



213564



213554

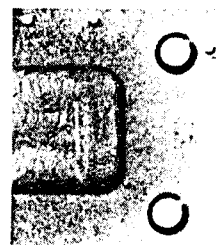


PLATE 11362 — ONE-FOURTH SIZE

221580



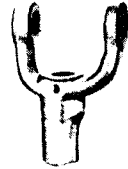
213530



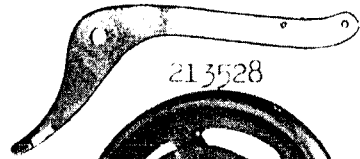
213558



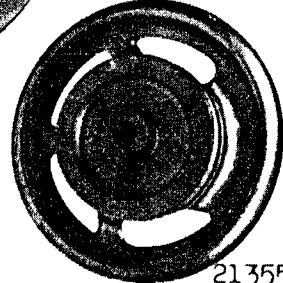
213545



227301

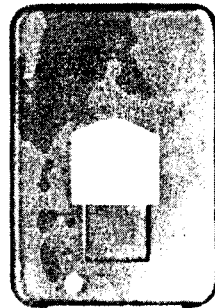


213528



213552

213546



213544

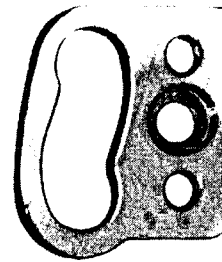


213460

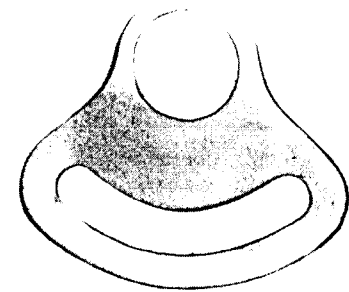


PLATE 11363 FULL SIZE

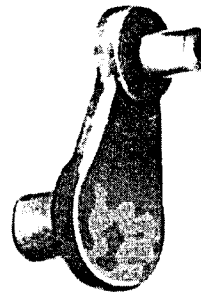
213404



213406



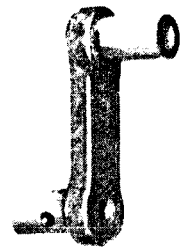
213467



213466



213441



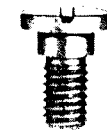
200818



200035



200262



213692



201827



213639



213696



200095



200066



200681



213711



200101



201522

201183



350355



PLATE 11364 - FULL SIZE

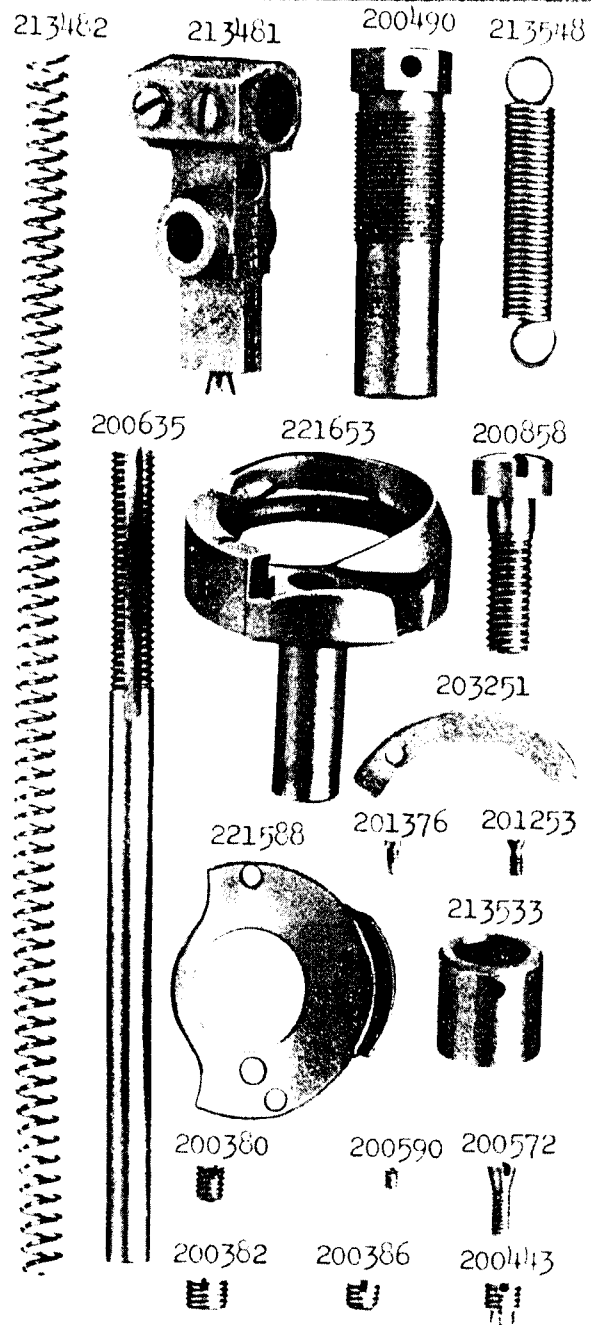


PLATE 11365 - FULL SIZE

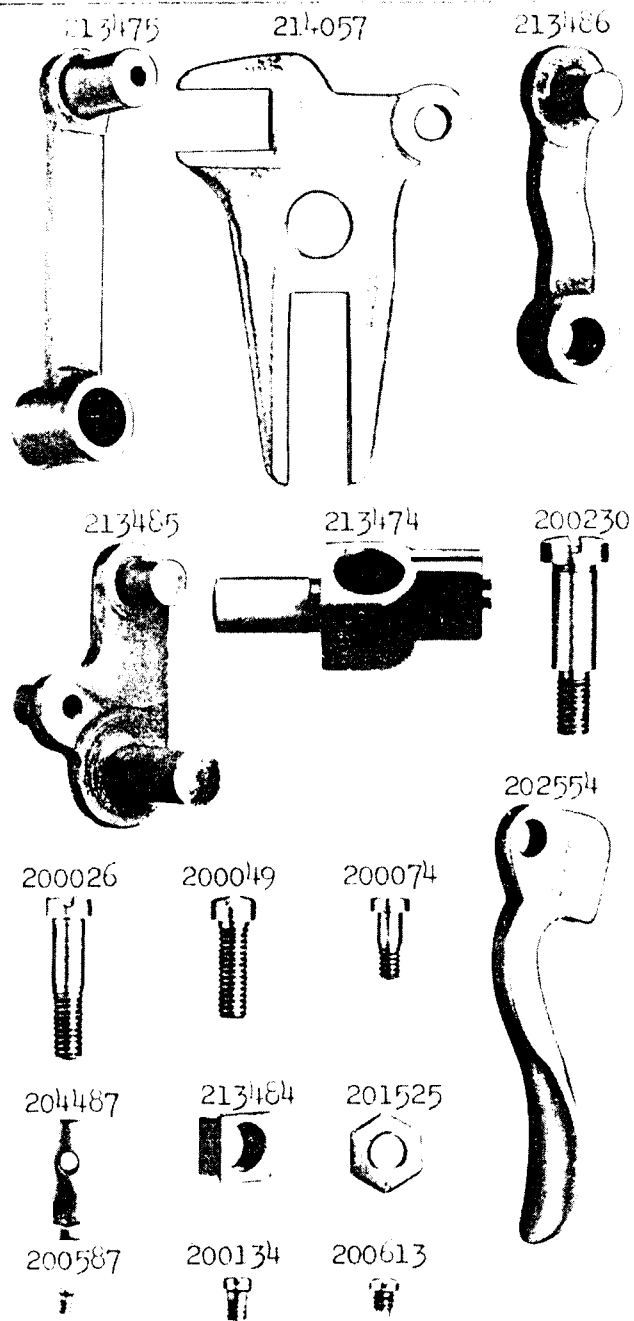


PLATE 11366 - FULL SIZE

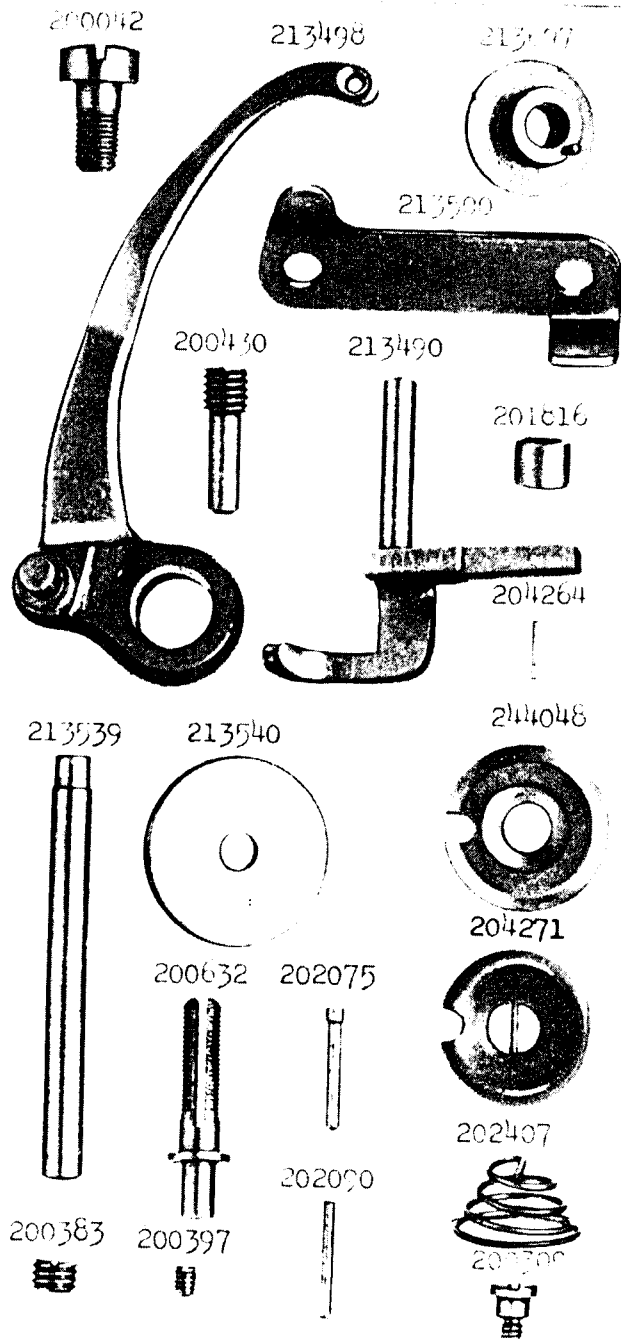


PLATE 11367 FULL SIZE

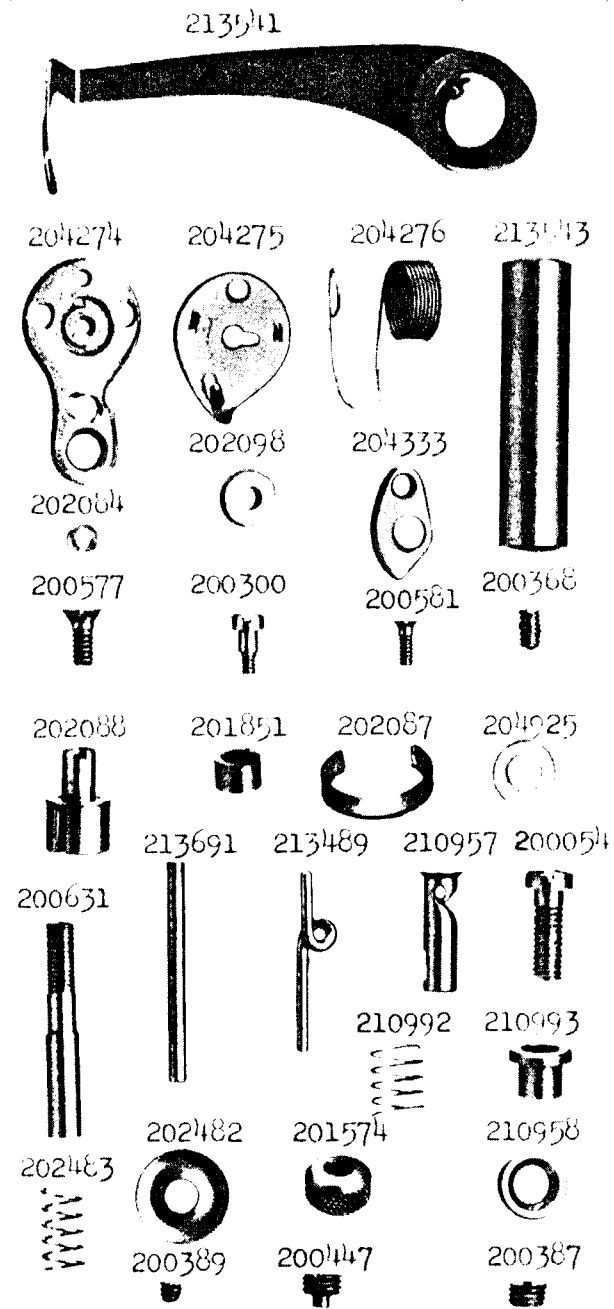


PLATE 11368--FULL SIZE

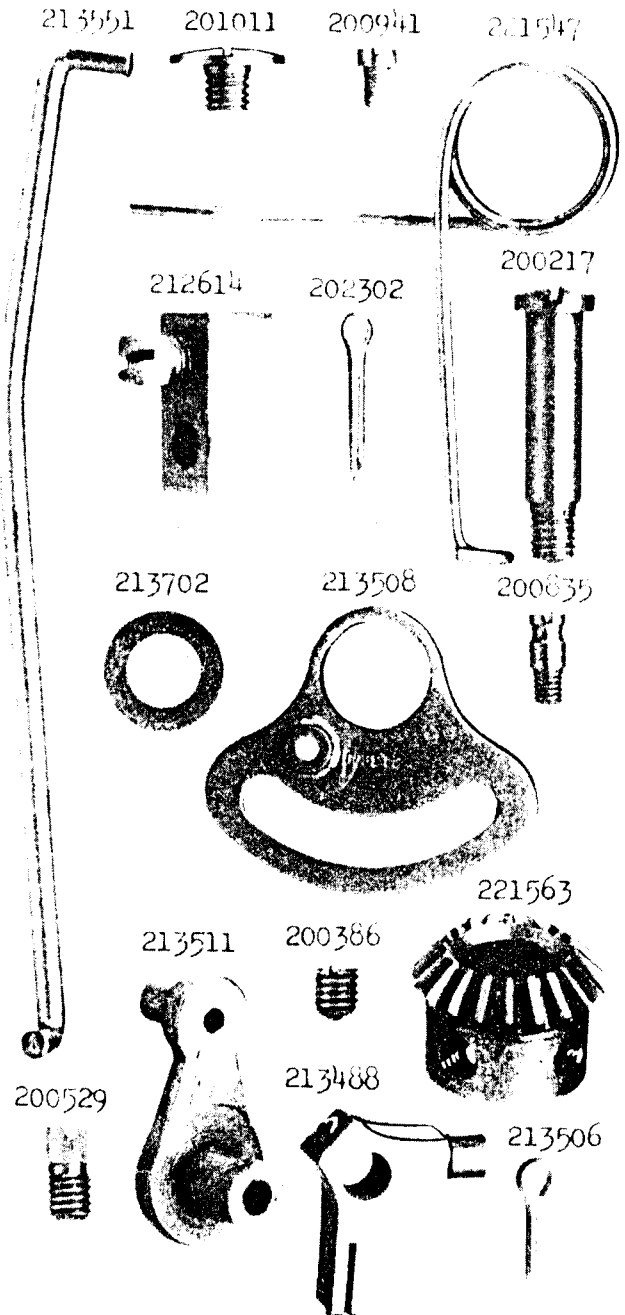


PLATE 11369 FULL SIZE

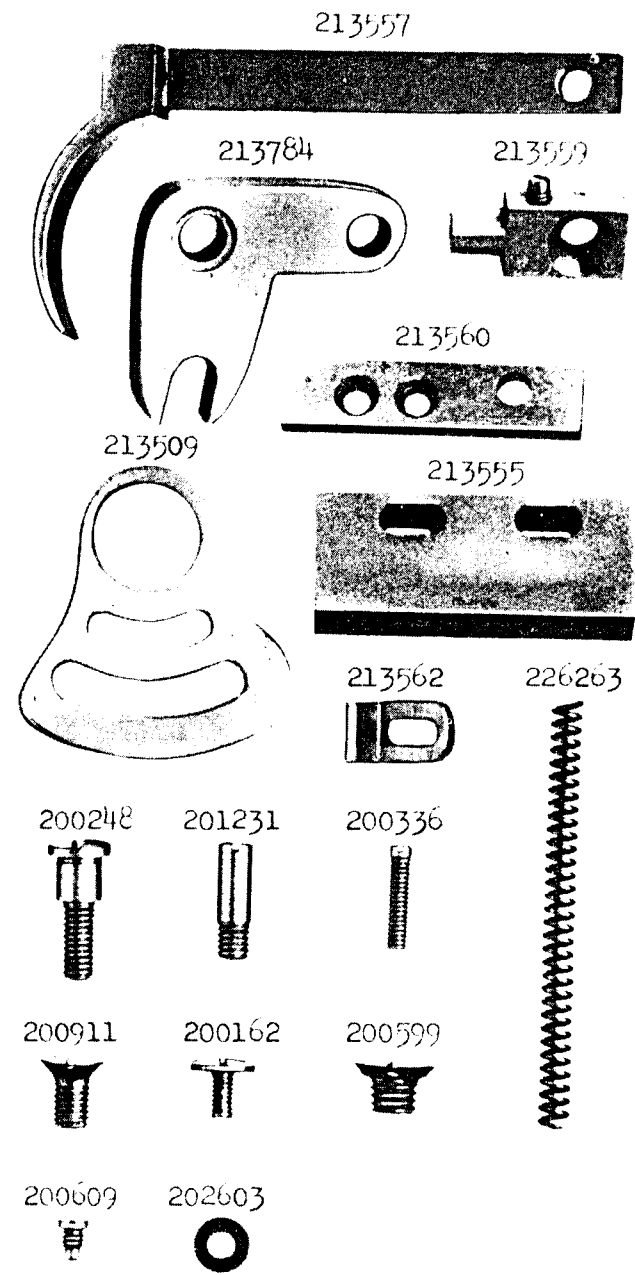


PLATE 11370 FULL SIZE

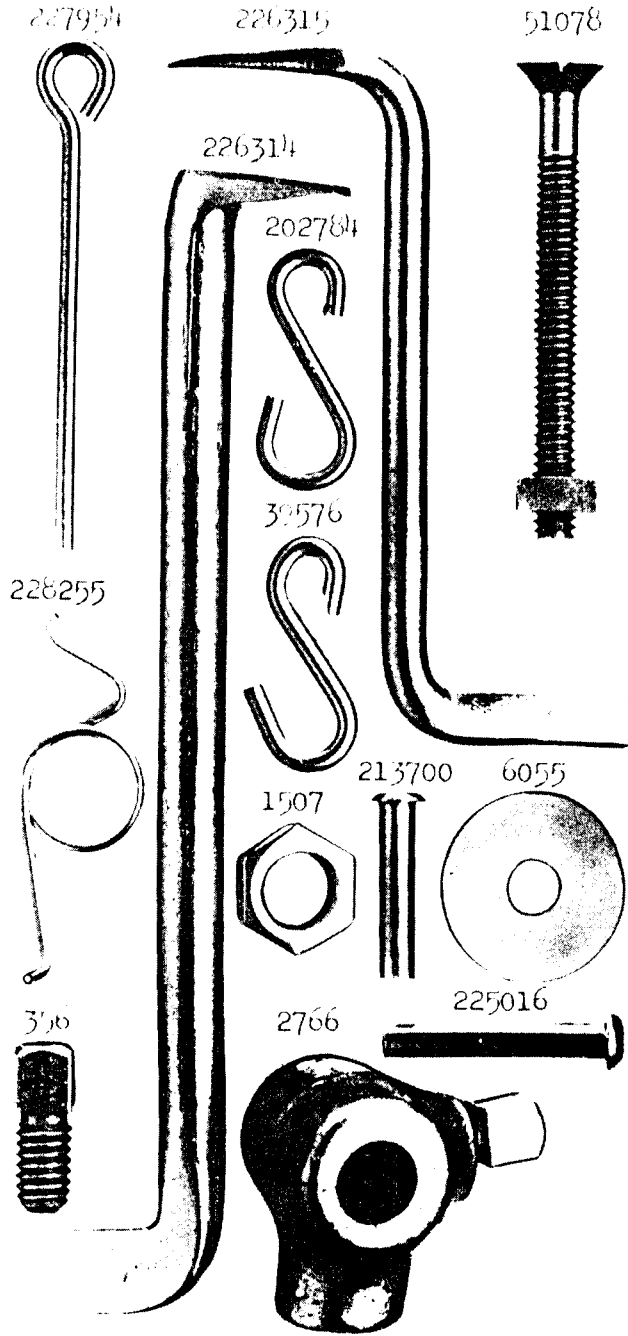


PLATE 11371 - ONE-HALF SIZE

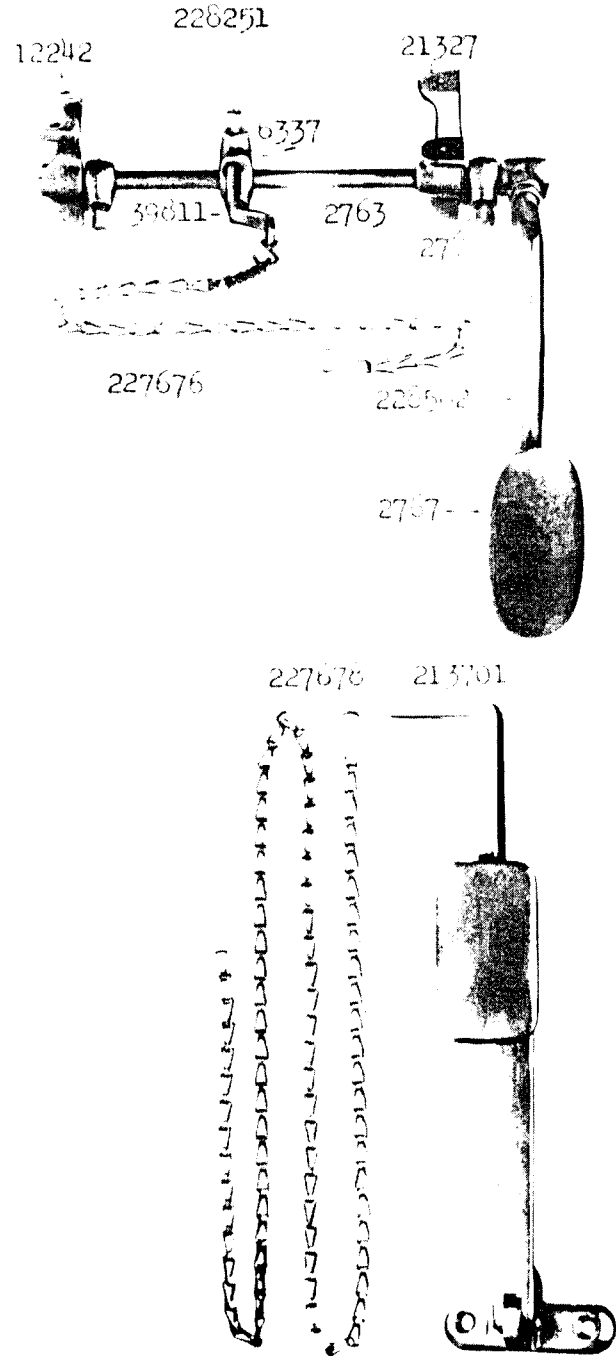
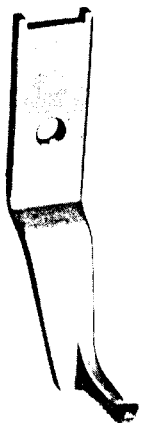


PLATE 11372 FULL SIZE

229760



229947



229948



229751



229946



229946

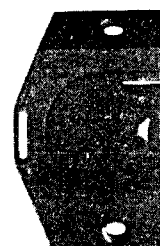


PLATE 11373 --ONE-HALF SIZE

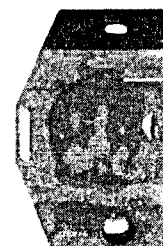
212851



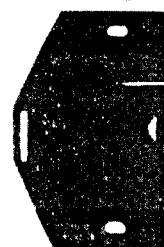
212852



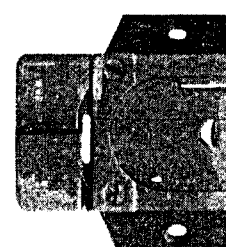
212879



214032



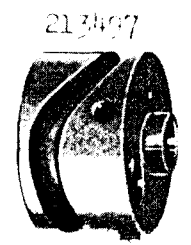
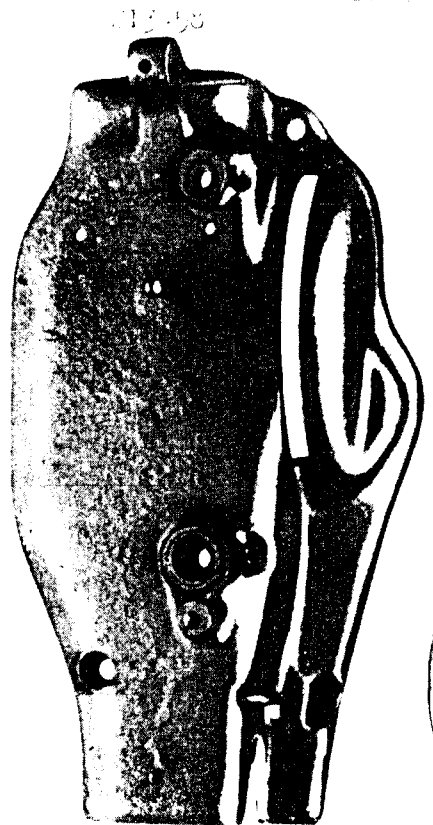
212855



212873



PLATE 11374 -- ONE-HALF SIZE



22003

